

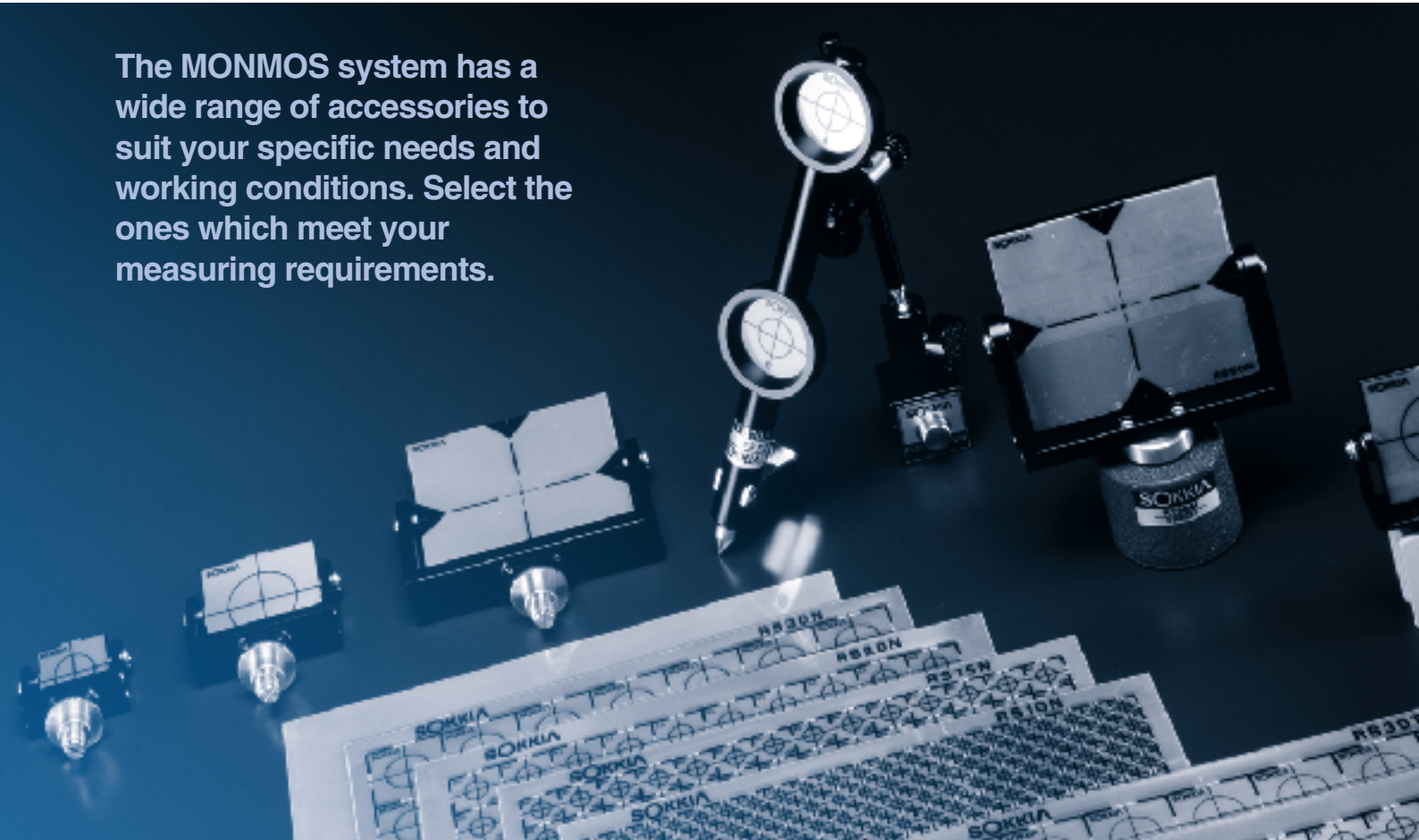

3-D COORDINATE MEASURING SYSTEM

MONMOS ACCESSORIES



The MONMOS system has a wide range of accessories to suit your specific needs and working conditions. Select the ones which meet your measuring requirements.

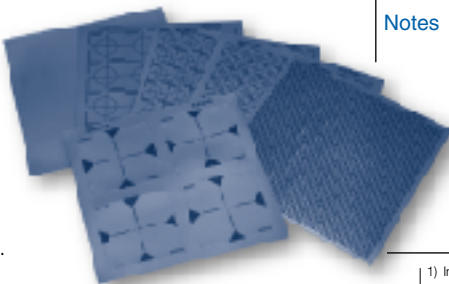

Reflective Sheets RS Series

The 0.4mm thick reflective sheets use microprisms and feature adhesive tape backing which enables direct attachment to the structure to be measured. The reflective sheets are easy to use, economical and come in a variety of sizes and shapes to satisfy the distance and location of the measuring points.

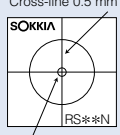
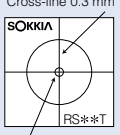
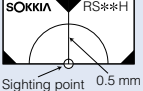

	Normal Type Reflective Sheets RS**N-R RS**N-K*	Thin Cross-line Type Reflective Sheets RS**T-R	Half Type Reflective Sheets RS**H-R	Reflective Sheets RS00-R RS00-K*
Size	10, 15, 20, 30, 50, 70, 90 mm	5, 10, 15, 20, 30 mm	10 x 20, 15 x 30, 25 x 50, 45 x 90 mm	230 mm
Prism constant	0mm	0mm	0mm	0mm
Notes	Cross-line 0.5 mm  Sighting point	Cross-line 0.3 mm  Sighting point The 0.3 mm cross-line allows accurate measurements at short distances.	 Sighting point 0.5 mm Suitable for measuring points in a corner without offset (See <Figure 1>).	 Without cross-line. Can be trimmed to desired size.

Notes: 1) Insert the size to "**".
 e.g. RS**T-R type targets in 5 x 5 mm, 10 x 10 mm, and 15 x 15 mm are named RS05T-R, RS10T-R, and RS15T-R respectively. For Half Type Reflective Sheets, insert the underlined numbers.
 2) * "K" type sheets can be used with the NET1200 only.

How to position the Half Type Reflective Sheets (side views)

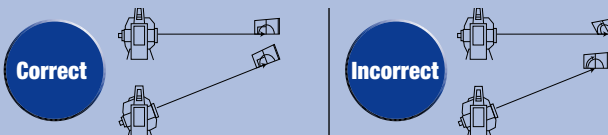

Notes on the use of Half Type Reflective Targets

Because Half Type Reflective Targets are half the size of normal targets, error occurs if they are tilted to and fro. Position them so that the surface of the target creates a right angle with the measuring beam.

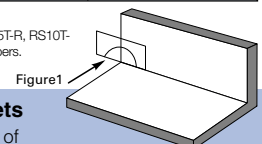



MONMOS

*A wide range of accessories
for increased field
productivity*



Special targets using the reflective sheets

Reflective targets are available in various forms to meet your specific needs. They can be easily attached with magnets or screws to facilitate measurement of hidden points or precise connection of coordinate systems.

The location of the targets for connecting coordinate systems

When measuring a large object, it is necessary to place targets which connect multiples of coordinate systems. Locate the targets outside the object and make the inner angles wide to achieve better accuracy.

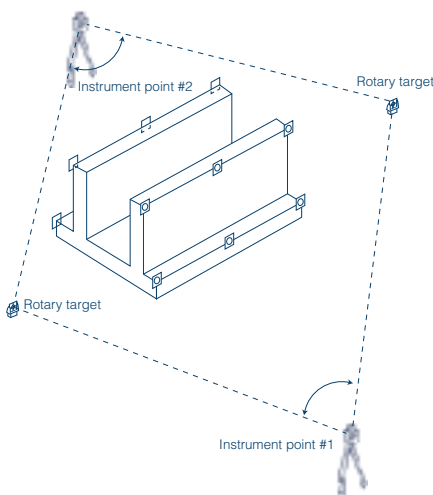

RT50M, RT90M Magnetic Type Rotary Targets

Size of reflective surface:

RT50M: 50 x 50 mm
RT90M: 90 x 90 mm

Prism constant:

0 mm

Setting:

With the strong magnet fitted at the base.

Features and usage:

The reflective surface rotates to a full 360° on a single center to allow measurement from any direction. Suitable for measuring the datum point or the connecting points of coordinate systems.

Measuring range:

RT50M: Same as RS50N-R
RT90M: Same as RES90N-R

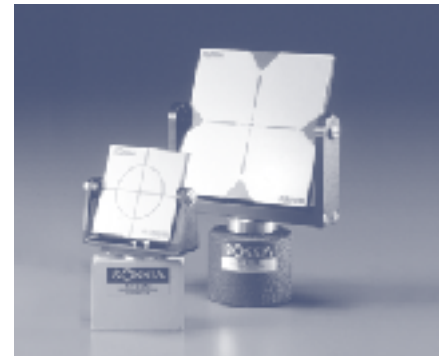

RT30G10, RT50G10, RT90G10 Anchor Grip Type Rotary Targets

Size of reflective surface:

RT30G10: 30 x 30 mm
RT50G10: 50 x 50 mm
RT90G10: 90 x 90 mm

Prism constant:

0 mm

Setting:

With a male screw ($\phi 10$ mm) at the bottom. Can be easily attached to an object if it is tapped to M10 standard.

Features and usage:

The reflective surface rotates to a full 360° on a single center to allow measurement from any direction. Suitable for measuring the datum point or the connecting points of coordinate systems.

Measuring range:

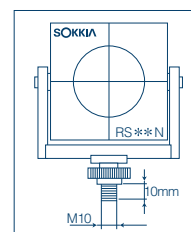

RT30G10:
Same as RS30N-R
RT50G10:
Same as RS50N-R
RT90G10:
Same as RS90N-R

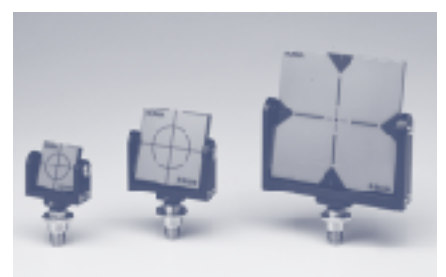

2RT310A Two-Point Target

Prism constant:

0 mm

Setting:

Fixed with the magnet arm.



Features and usage:

Suitable for measuring hidden points. Vertical positioning of the pole is not necessary. Measure the two targets on the pole. The coordinate values at the tip of the pole are calculated from the pole length and the coordinate values of the two targets. This function is included in the Control Terminals.

Measuring range:

Same as RS30N-R

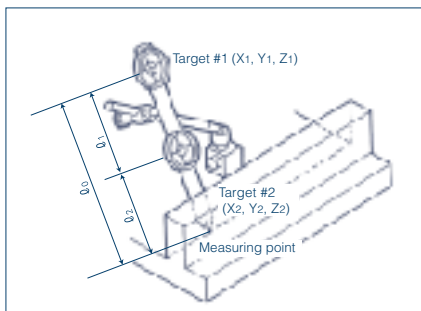

RT1A High-Precision Target

Size of reflective surface:

90 x 90 mm

Prism constant:

0mm

Setting:

With the tribrach for setup on tripods. Centered by using the optical plummet and leveled by the tubular level.

Features and usage:

For measurements of datum points on the ground.

Measuring range:

Same as RS90N-R

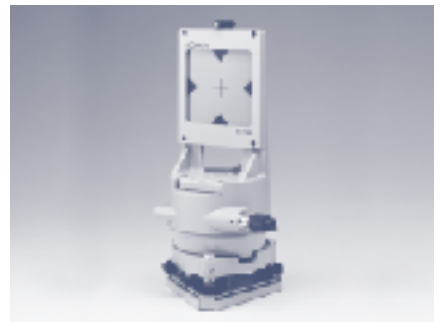

Targets for long distance measurements

CPS12 High-Precision Glass Prism

Prism constant:

-27 mm

Setting:

Use the tribrach for setup on tripods. Centered by using the optical plummet and leveled by the tubular level.

Features and usage:

For measurement of datum points on the ground.

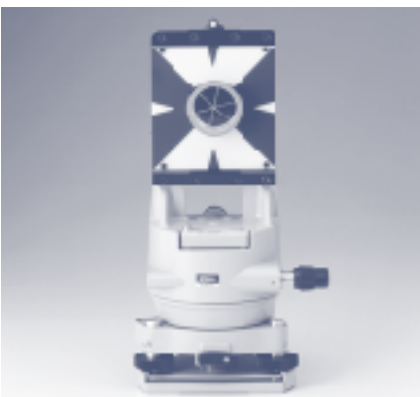

Sokkia's AP series prisms are also available. Please refer to the NET series brochures for measuring range and accuracy.

RC50, RC100 Plastic Type Reflective Targets

Size of reflective surface:

RC50: 50 x 50 mm
RC100: 100 x 100 mm

Thickness:

7.9 mm (both RC50, RC100)

Prism constant:

0 mm

Setting:

4 holes at each corner.

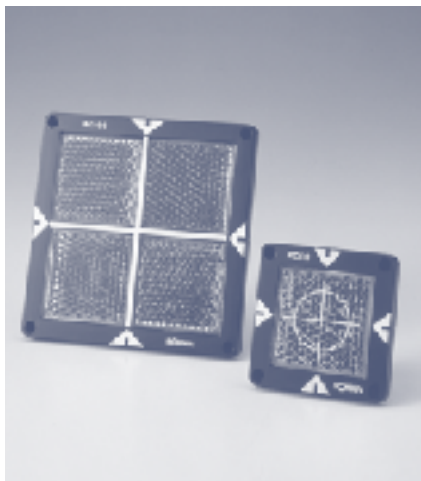

Features and usage:

Suitable for precision measurement at long distance. (e.g. landslides)

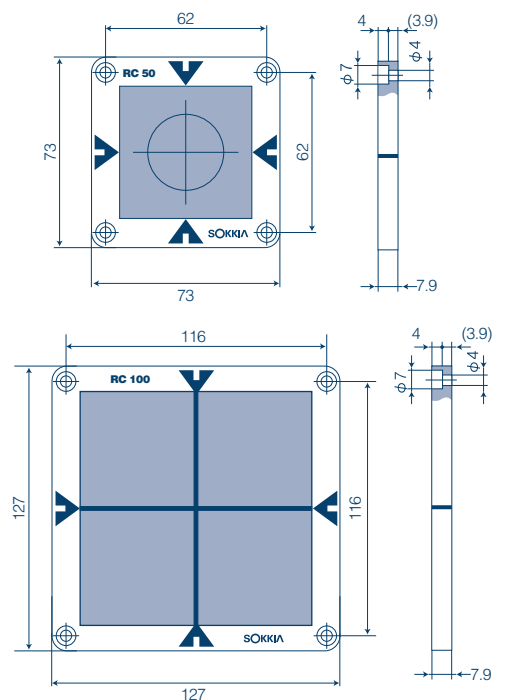

Accessories to meet specific requirements

TK1, TK2, KUS1 - allow measurements without offset

TK1 Corner Half Target Plate Set

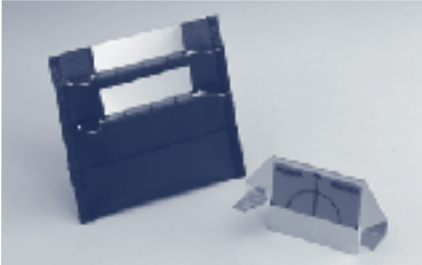

Use the Corner Half Target Plate with the KUS1's magnetic block, which firmly fixes the target plate into places where it is difficult to set a normal type target such as at a corner of a structure. A half target RS50H-R is fitted.

Consists of:
Target plate x 3
Case x 1

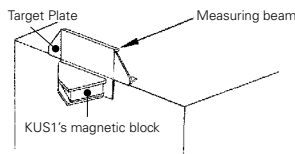

TK2 Surface Half Target Plate Set

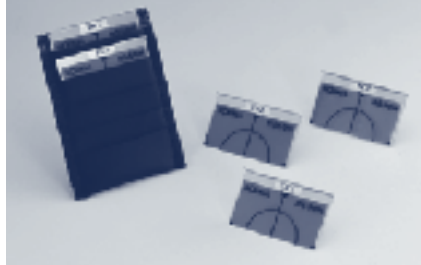

The Surface Half Target Plate can be set up easily with the KUS1's magnetic block. A half target RS50H-R is fitted.

Consists of:
Target plate x 5
Case x 1

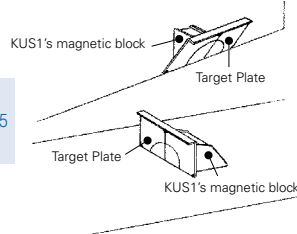

KUS1 Magnetic Block Set

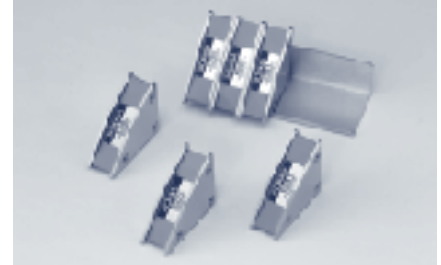

The Magnetic Block holds the target plates of TK1 and TK2. It has corners in various angles so that the reflective surface of the targets creates an angle as close to 90° as possible with the measuring beam.

Consists of:
Magnetic block x 6
Holder x 1

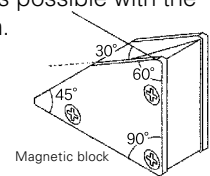

KUS2 Tripod Stopper



KUS2 is used to set up a tripod on an iron surface. A strong magnet is fitted to the reverse side and hold the tripod leg firmly in place. Place three pieces in a triangle, and put the tripod shoes into the centers.

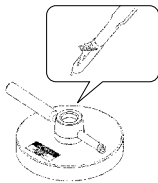

(Three pieces are necessary to set up a tripod.)

MTS1 Magnetic Target Set



This is a set of accessories selected for shipbuilding and bridge-building.

Consists of:

- RT50M x 2
- RT90M x 2
- TK1 x 2 sets
- TK2 x 4 sets
- KUS1 x 3 sets
- KUS2 x 3
- Carrying case x 1

LA11 Illuminating Light for Reflective Targets



The LA11 illuminates targets at night or in tunnels. It can be easily attached to the peep sight of the NET2100. It requires two R6/AA batteries for about 2.5 hours of operation. (For NET2100 only)

Other Accessories

Diagonal Eyepieces

The diagonal eyepieces allow sighting at steep angles up to zenith.
DE25: for NET1200
DE17A: for NET2100



Objective Solar Filters

The OF2A and OF3A feature a flip type design.

OF3A: for NET1200
OF2-OF2A: for NET2100



OF2A-OF3A

SC85 Soft Case for Accessories

A large soft case with a shoulder strap for accessories such as rotary targets and the Control Terminals.



SC82 Soft Case for Reflective Sheet

SC82 can contain 230 x 230 mm reflective sheets.



Sokkia is a sponsor
of the International Federation
of Surveyors.



SOKKIA CO., LTD.

ISO9001 Certified (JQA-0557)
http://www.sokkia.co.jp/english/
INTERNATIONAL SALES DEPARTMENT
260-63 HASE, ATSUGI, KANAGAWA, 243-0036 JAPAN
PHONE +81-46-248-7984 FAX +81-46-247-1731